

1

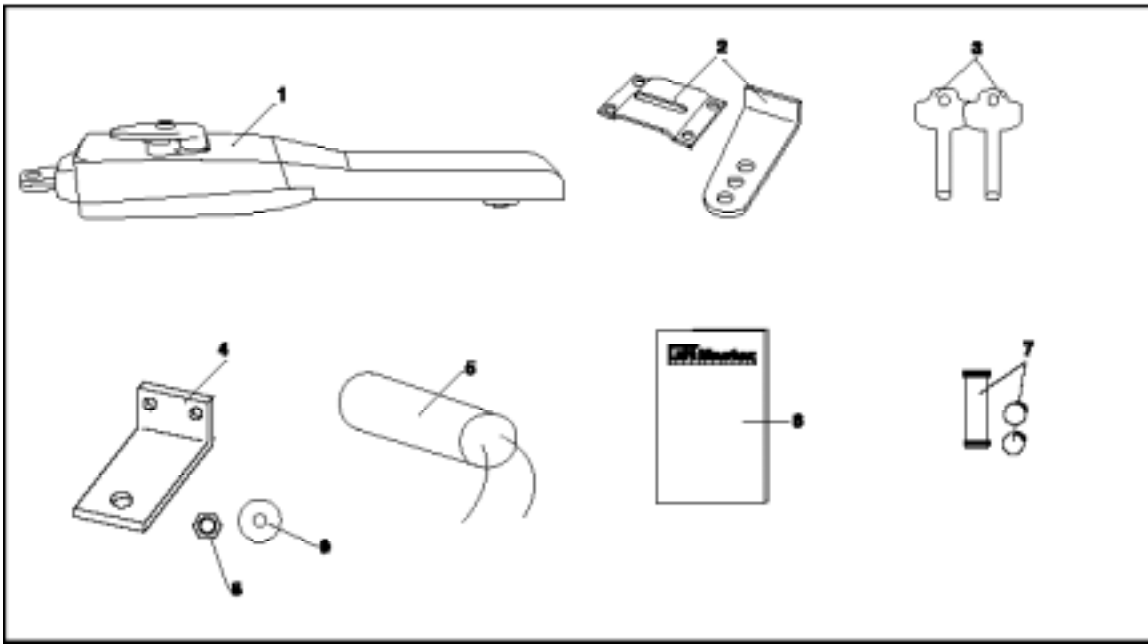

2

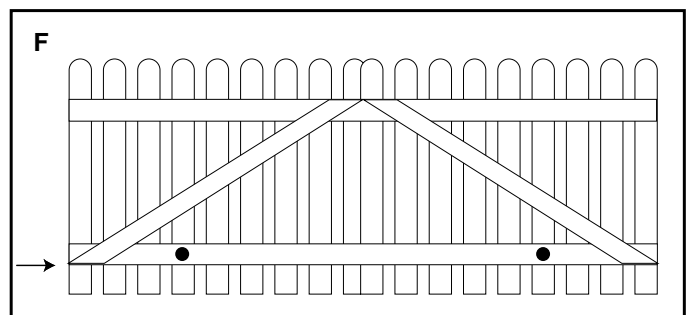
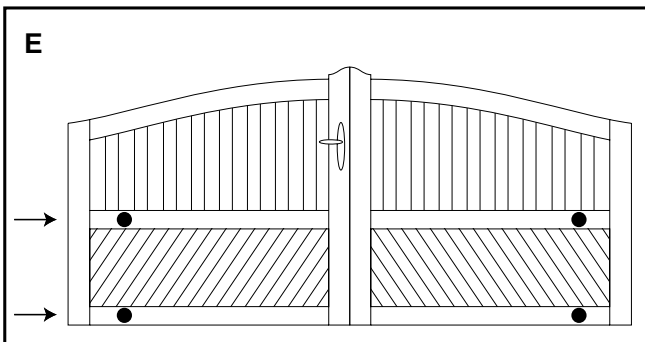
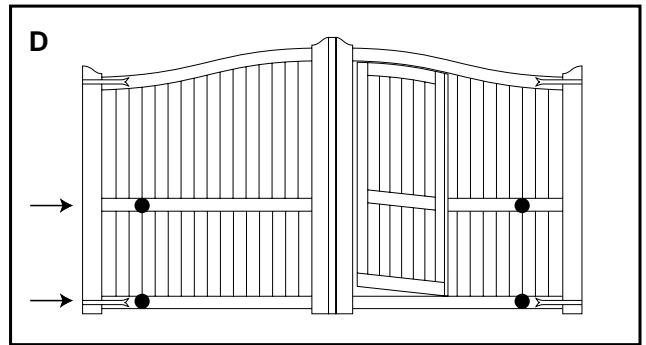
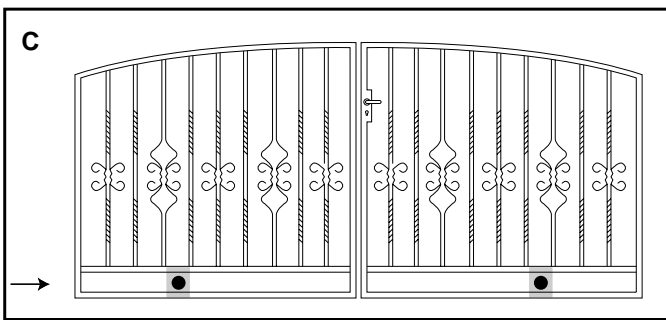
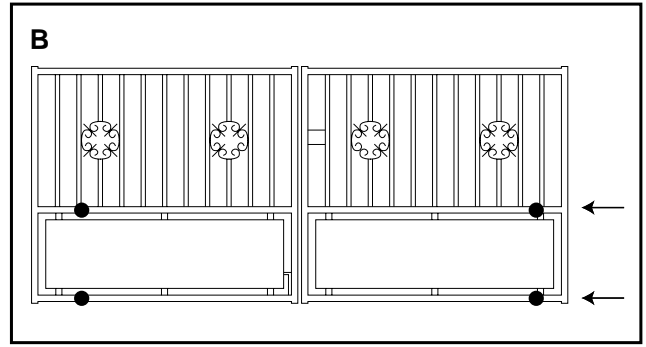
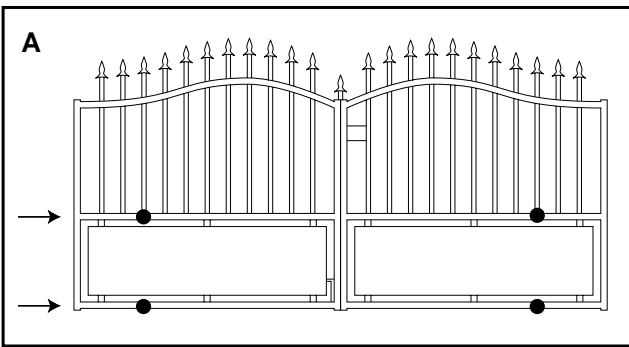

3

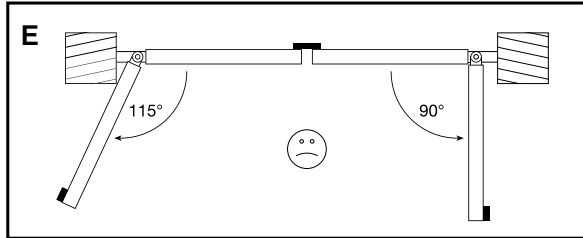
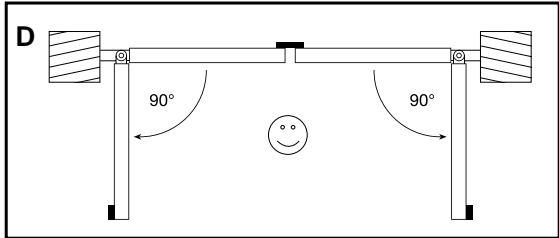
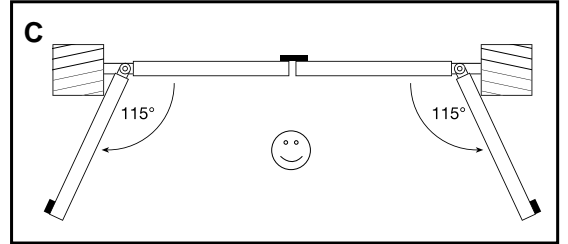
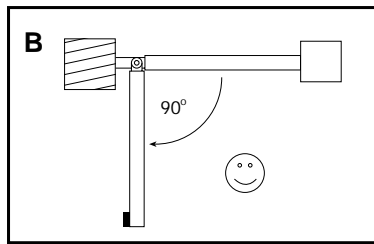
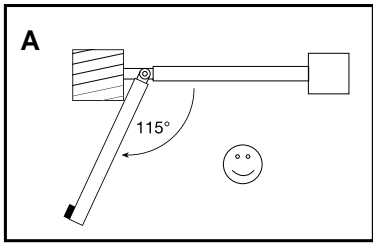

F

		A							
		10	12	14	16	18	20	22	
B	10		115°		110°	105°	100°		
	12		110°	121°	101°	100°	94°		
14		108°	105°	93°	100°	92°			
16		106°	95°	87°					
18			93°						
20									
22									

A=15cm = ca. 90°
B=15cm

4

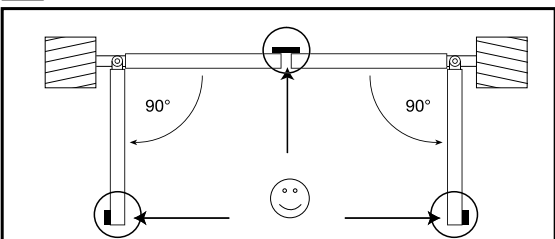

5 A

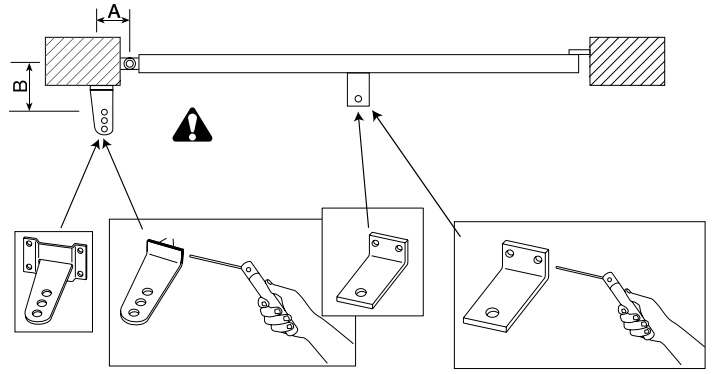
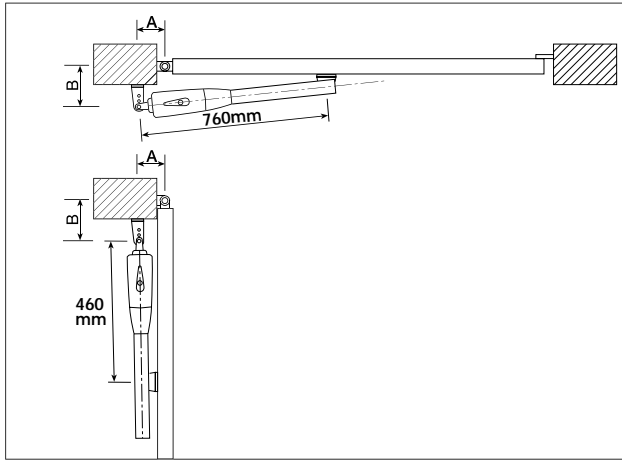

B

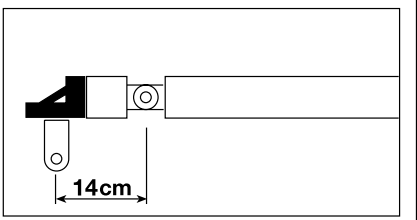

C

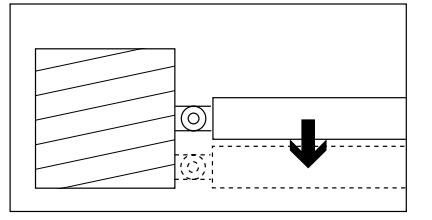

D

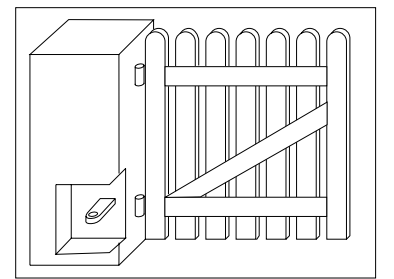

6

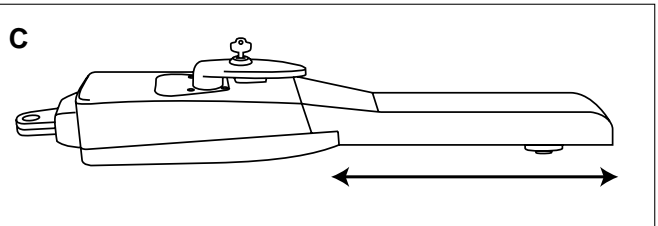
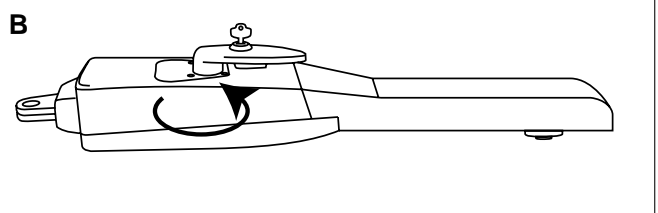
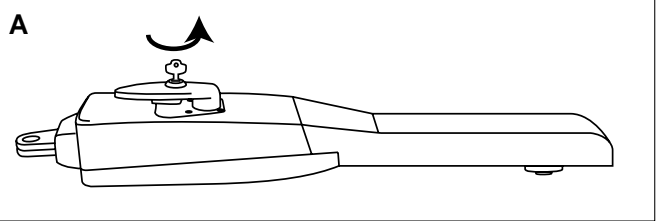

7

